



Type(s)
Project
Date
Notes

GENERAL INFORMATION

The ETC ColorSource Spot brings together the affordability of a four-color light engine with the build-quality and support of an ETC product. Using a unique mix of red, green, blue and lime LED emitters, the ColorSource Spot offers an amazing range of color and depth, unlike other low-cost LED fixtures. Because it utilizes standard ETC optics, adapters and accessories, it is a versatile solution for any lighting need.

APPLICATIONS

- Theatres and performance spaces
- Houses of worship
- Universities and schools
- Hospitality
- Retail
- Exhibition centers
- Meeting rooms
- Clubs
- Cafeteriums

PRODUCT FEATURES

- ETC's RGB-L array (red, green, blue and lime)
 - Also available in Deep Blue, which replaces the blue LEDs with indigo for rich, saturated blues and magentas
- Simple user interface with seven-segment display
- powerCON® in and thru
- DMX/RDM in and thru (5-pin XLR)
- LED droop compensation
- Optically calibrated
- Tour-ready, aluminum housing
- Combine with available adapters to transform your fixture into a fully functional Fresnel or CYC light

ORDERING INFORMATION

ColorSource Spot Light Engine with Shutter Barrel

(For use with fixed-field lens tubes only)

MODEL	DESCRIPTION	ETL PART NUMBER	CE PART NUMBER
CSSPOTS	ColorSource Spot with shutter barrel, black	7413A1001	7413A1201
CSSPOTDBS	ColorSource Spot Deep Blue with shutter barrel, black	7413A1041	7413A1241

ColorSource Spot Light Engine Body

(For use with zoom lens tubes and adapters and for retrofit of existing fixtures)

MODEL	DESCRIPTION	ETL PART NUMBER	CE PART NUMBER
CSSPOT	ColorSource Spot, body only, black	7413A1000	7413A1200
CSSPOTDB	ColorSource Spot Deep Blue, body only, black	7413A1040	7413A1240

Color options: -1 = white, -5 = silver gray, -8 = custom colors.
 Fixture ships with a soft-focus diffuser in a gobo holder, a c-clamp and a 1.5 m powerCON power-input cable with a connector of choice. See page six for connector options.
 Please note: Lens tubes to be ordered separately. C-clamps included in NA regions only.



PRODUCT SPECIFICATIONS

Source

LED details	60 Lumileds LUXEON® Rebel LED
Max lumens	6,932
Lumens per watt	42.4
L70 rating (hours to 70% output)*	54,000 hours (both variants)

Color

Colors used	Spot: Red, green, blue, lime Spot DB: Red, green, indigo, lime
Color temperature range	Color mixing
Calibrated array	Yes
Red shift	No

Optical

Beam angle range	Swappable lens tubes between 5-90 degrees
Gate size	79-24 mm
Aperture size	6.25–14 in (depending on lens tube)
Pattern projection	Yes
Pattern size	A or B
Camera flicker control/Hz range	1,200 Hz (default) and 25,000 Hz (via RDM)
Notes	Can be used with LED CYC and Fresnel adapters

Control

Input method	DMX512 via 5-pin XLR connector
Protocols	DMX512/RDM
Modes (footprint)	4 modes, see page 7
RDM configuration	Yes
UI type	Seven-segment, three-button interface
Local control	Yes
Onboard presets	Yes (12)
Onboard sequences	Yes (5)
Onboard effects	No
FixtureLink	Yes
Notes	15-bit virtual dimming engine

Electrical

Voltage range	100–240 VAC 50/60 Hz
Input method	powerCON power in and thru
Inrush	28 A at 120 V (First half-cycle) 46 A at 240 V (First half-cycle)
Fixtures per circuit	9 fixtures (15 A power thru connector) or 10 fixtures (R20 module or similar)
Wattage typical/standby	168 W/1.19 W at 100 V 166 W/2.07 W at 120 V 166 W / 1.5 W at 240 V
Current draw typical/standby	1.69 A/0.05 A at 100 V 1.39 A/0.05 A at 120 V 0.72 A/0.05 A at 240 V

Thermal

Ambient operating temp	0°–40° C (32°–104° F)
Fan (controllable)	Yes (no)
Droop compensation	Yes
dB range	21.2 dBA average at 1 m
BTUs/hour	504.78

Physical

Materials	Die-cast, all metal housing
Color options	Black, white, silver, or custom color
Mounting options	Yoke
IP rating	IP20
Weight	7.7 kg (17 lb) (without lens)
Included accessories	Hanging yoke, 1.5 m power cable, soft-focus diffuser in an A-size gobo holder
Notes	See page 6 for power cable options

Warranty

Fixture	5 years
LED array	10 years

Regulatory and Compliance

Approved regulatory standards	cETLus Listed Conforms to UL 1573 Listed Conforms to UL 924 Listed Certified to CSA C22.2 No. 166 Listed Certified to CSA C22.2 No. 141 Listed CE Compliant EAC
-------------------------------	---

***Note about LED luminaire lifetime:**

ETC utilizes a nationally recognized third-party lab for luminaire testing according to IES LM-84. See etconnect.com/About/News/ETC-Fixture-Ratings-and-Warranties-Extended.aspx.

All LED sources experience some lessening of light output and some color shift over time. LED output will vary with thermal conditions. In individual situations, LEDs will be used for different durations and levels. This can eventually lead to minor alterations in color performance, necessitating slight adjustments to presets, cues or programs.

PRODUCT FEATURES

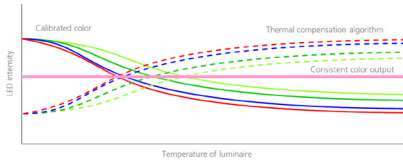

LED DROOP COMPENSATION

ETC’s custom software adjusts for the changes that naturally occur as LEDs heat up and cool down so you never have to worry about color shift.



RGB-L ARRAY

The custom four-color blend of LEDs incorporates a hint of lime to increase spectral reach and color depth.



SIMPLE USER INTERFACE

The simple seven-segment display and navigation buttons enable quick setup and recall of built-in presets.

COLOR METRIC INFORMATION

COLORSOURCE SPOT 3200 K TM-30-18

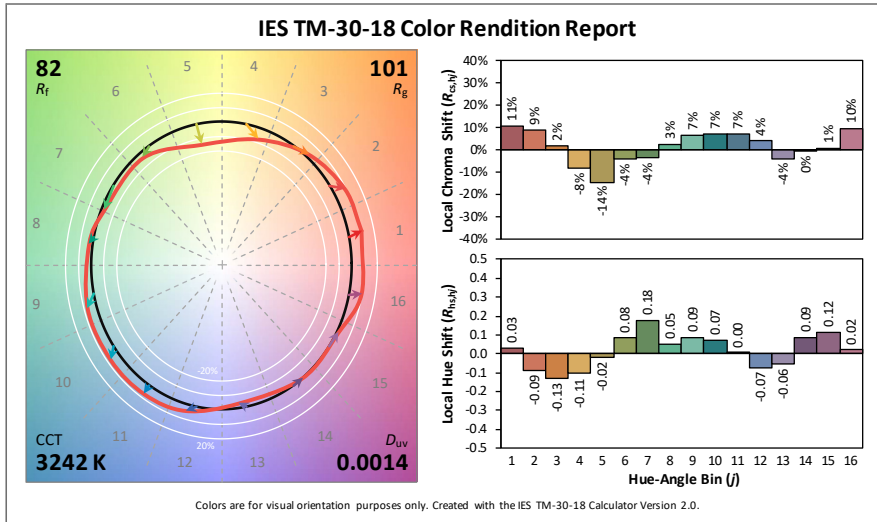

COLORSOURCE SPOT 5600 K TM-30-18

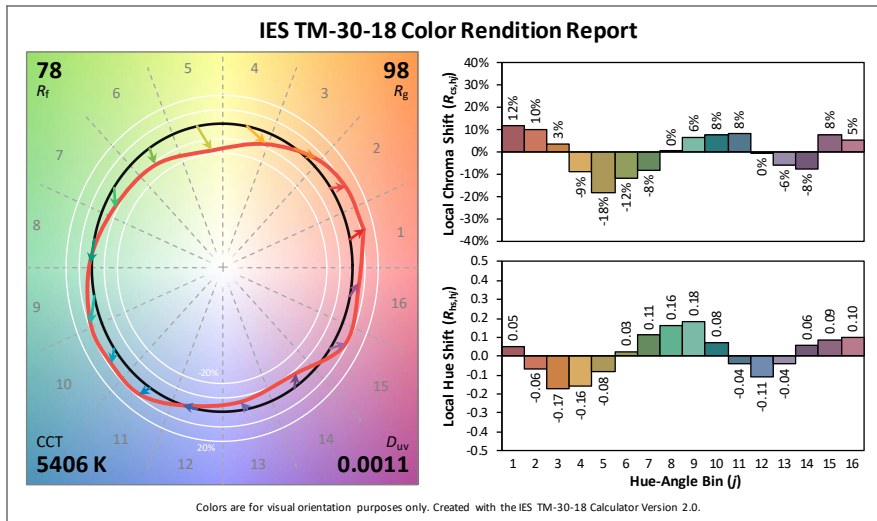

COLOR METRIC INFORMATION

COLORSOURCE SPOT DEEP BLUE 3200 K TM-30-18

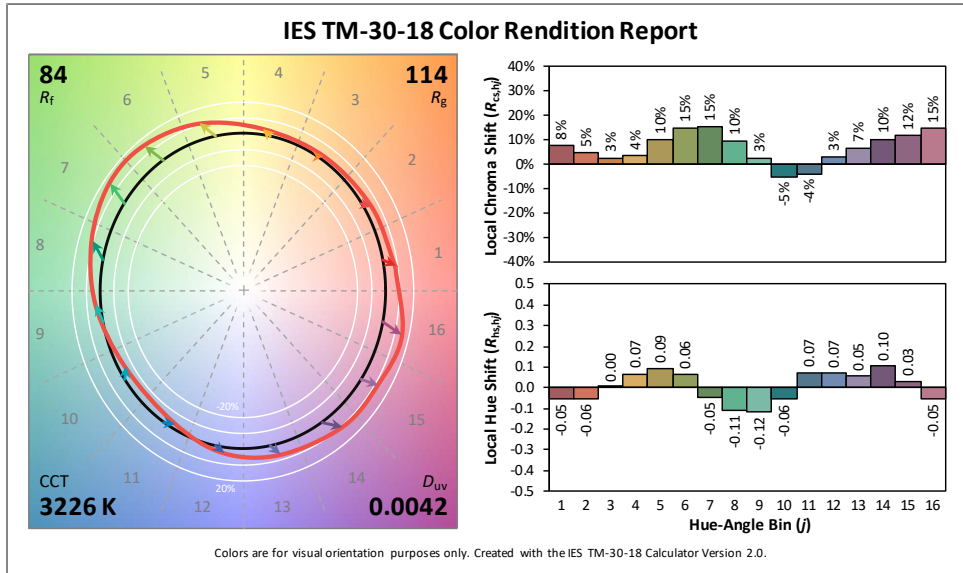

COLORSOURCE SPOT DEEP BLUE 5600 K TM-30-18

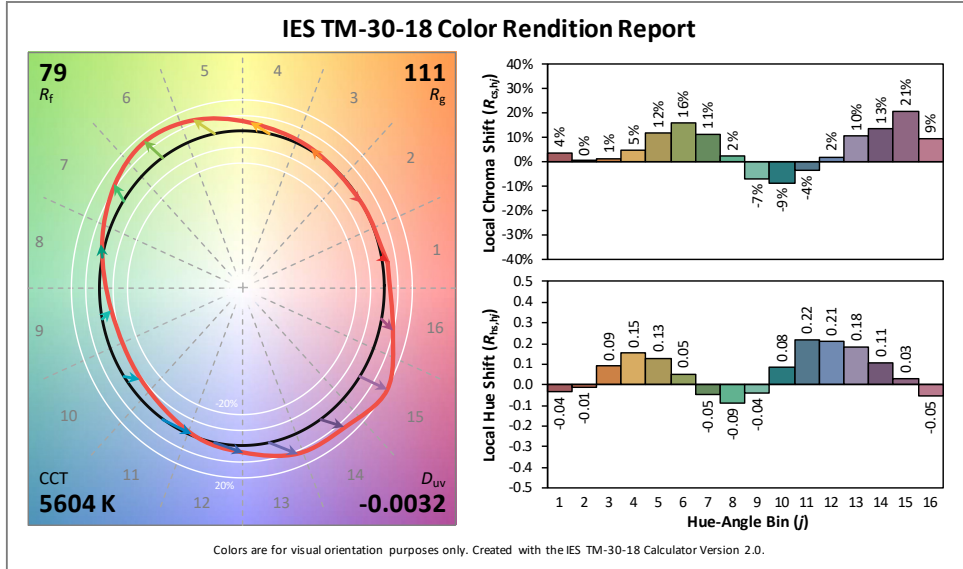

COLOR METRIC INFORMATION

ColorSource Array options – Original vs. Deep Blue

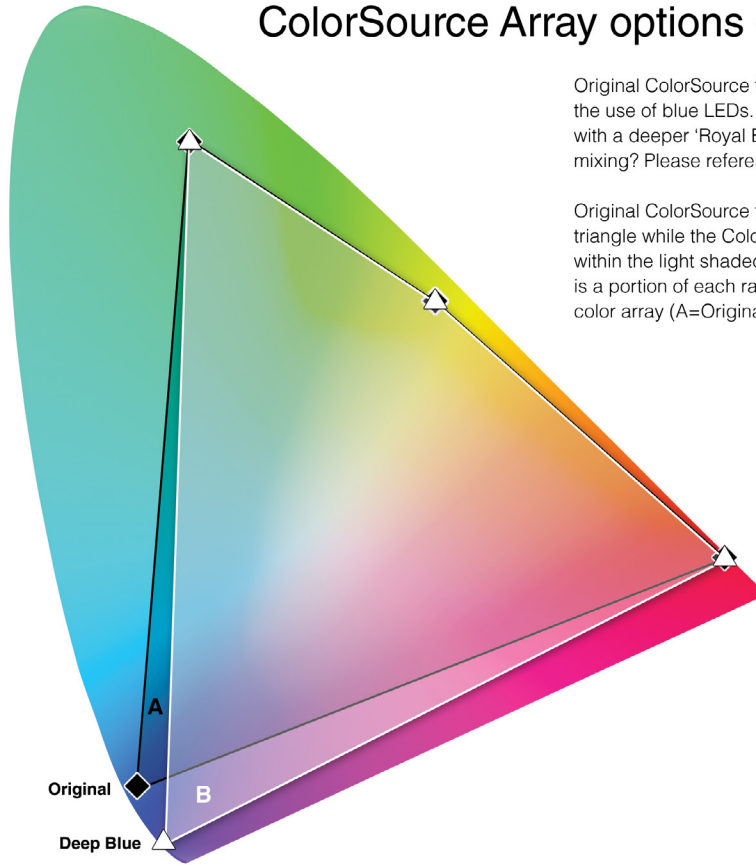

Original ColorSource fixtures use an RGB-L array where the 'B' represents the use of blue LEDs. ColorSource Deep Blue replaces those blue LEDs with a deeper 'Royal Blue' (indigo) LED. How does this impact your color mixing? Please reference the color chart.

Original ColorSource fixtures can reach any color within the dark shaded triangle while the ColorSource Deep Blue fixtures can reach any color within the light shaded triangle. While much of these areas overlap, there is a portion of each range that can only be reached by the respective color array (A=Original, B=Deep Blue).

Common gels found in original ColorSource

Roscolux 095, 075, 076
Lee 363, 119, 721, 722, 132, 141, 183, 172, 325

Common gels found in ColorSource Deep Blue

Roscolux 384, 385, 382, 059, 358, 347, 049, 349,
046, 124, 027, 120
Lee 126, 049, 798, 707, 181, 071, 120, 716

PHOTOMETRY INFORMATION

Degrees and Lumens

DEGREE	MAXIMUM OUTPUT FIELD LUMENS		DISTANCE TO ACHIEVE 50 FC	
	RGB-L	Deep Blue	RGLB	Deep Blue
5	5,020	4,682	89.0 ft / 27.2 m	89.0 ft / 27.2 m
10	5,429	5,063	70.0 ft / 21.4 m	69.5 ft / 21.2 m
14	6,173	5,757	49.0 ft / 15.0 m	49.0 ft / 15.0 m
19	5,426	5,061	40.0 ft / 12.2 m	40.0 ft / 12.2 m
19 EDLT	6,155	5,740	39.0 ft / 11.9 m	38.7 ft / 11.8 m
26	5,543	5,169	32.5 ft / 9.9 m	32.5 ft / 9.9 m
26 EDLT	6,932	6,494	32.3 ft / 9.9 m	32.3 ft / 9.9 m
36	6,680	6,230	23.8 ft / 7.3 m	23.6 ft / 7.2 m
36 EDLT	6,919	6,453	24.0 ft / 7.3 m	24.0 ft / 7.3 m
50	6,670	6,221	18.0 ft / 5.5 m	17.8 ft / 5.4 m
50 EDLT	7,074	6,598	17.0 ft / 5.2 m	16.9 ft / 5.2 m
70	7,474	6,971	13.4 ft / 4.1 m	13.4 ft / 4.1 m
90	6,952	6,483	11.8 ft / 3.6 m	11.7 ft / 3.6 m
15-30	6,464	6,029	33.0 ft / 10.1 m	33.0 ft / 10.1 m
25-50	6,974	6,505	23.2 ft / 7.1 m	23.2 ft / 7.1 m

See *ColorSource Spot Photometry Guide*, available at etcconnect.com for full photometry information.

ADDITIONAL ORDERING INFORMATION

Fixture Accessories

MODEL	DESCRIPTION	PART NUMBER	
400CC	C-clamp (not included with CE fixtures)	7060A2009 (not CE)	
400SC	Safety cable	7060A1022	
400PH-A	Pattern holder (A size) (included)	7060A1013	
400PH-B	Pattern holder (B size)	7060A1014	
400PH-G	Glass pattern holder	7060A1019	
400RS	Drop-In iris	7060A1012	
400CF	Color frame (6.25 in)	7060A3043	
407CF	Square color frame (7.50 in)	7061A3007	
400DN	Donut	7060A1015	
400TH	Top hat, 6.25 in/159 mm	PSF1021	
400PTH6	Top hat, 7.5 in/191 mm	PSF1023	
410TH	Top hat, 12 in/305 mm (for 10° lens tubes)	PSF1024	
405TH	Top hat, 14 in/356 mm (for 5° lens tubes)	PSF1025	
400HH	Half hat	PSF10216	
DPSJ-X	25 ft powerCON-to-Edison input power cable with inline switch	7400B7030 (not CE)	

Power Input Cables

Use information below to order 5 ft power input leads with factory-fitted connectors. CE fixtures ship with powerCON to bare end cables in the box.

MODEL	DESCRIPTION	PART NUMBER	
DPA-A	5 ft powerCON to parallel blade U-ground (Edison) connector	7410B7037-A (not CE)	
DPA-B	5 ft powerCON to 20 A two-pin and ground (stage pin) connector	7410B7037-B (not CE)	
DPA-C	5 ft powerCON to grounded 20 A twistlock connector	7410B7037-C (not CE)	
DPA-X	5 ft powerCON to bare-end power input lead	7410B7037-X (not CE)	

Power Thru Jumpers

Note: Power thru jumpers connect to a fixture's output (thru) connector to provide a link to successive fixtures.

MODEL	DESCRIPTION	PART NUMBER	
DPJ-5	5 ft powerCON-to-powerCON fixture-to-fixture jumper	7410B7020	
DPJ-10	10 ft powerCON-to-powerCON fixture-to-fixture jumper	7410B7010	

Diffusers

The Soft Focus Diffuser fits into a standard A-size pattern holder and delivers beautiful, homogenized light. You can also use the Soft Focus Diffuser with patterns for dappled and soft-edge projections.

The Smooth Wash Diffuser is used when extra-smooth blending of multiple ColorSource Spot luminaires is required. The smooth wash diffuser is placed into the gel-frame slot of the lens tube.

MODEL	DESCRIPTION	PART NUMBER	
S4LED-SFD	Soft Focus Diffuser (included)	7460A4019	
S4LED-SWD6	Smooth Wash Diffuser for 6.25 in gel frame slots	7460K1001	
S4LED-SWD7	Smooth Wash Diffuser for 7.5 in gel frame slots	7460K1002	
S4LED-SWD12	Smooth Wash Diffuser for 10° lens tubes	7460K1003	
S4LED-SWD14	Smooth Wash Diffuser for 5° lens tubes	7460K1004	

RJ45 to XLR Adapter Cables

MODEL	DESCRIPTION	PART NUMBER	
W6538	RJ45 to female 5-pin XLR adapter (6 ft)	W6538	
W6539	RJ45 to male 5-pin XLR adapter (6 ft)	W6539	

PREFERRED LENSING OPTIONS (Lenses sold separately)**Fixed Beam Lenses**

MODEL	DESCRIPTION	PART NUMBER	
LED50LT	LED-specific 50° EDLT lens	7460A2008	
LED50LT-1	LED-specific 50° EDLT (white) lens	7460A2008-1	
436EDLT	36° EDLT lens	7060A2048	
436EDLT-1	36° EDLT (white) lens	7060A2048-1	
426EDLT	26° EDLT lens	7060A2047	
426EDLT-1	26° EDLT (white) lens	7060A2047-1	
419EDLT	19° EDLT lens	7060A2046	
419EDLT-1	19° EDLT (white) lens	7060A2046-1	
490LT	90° lens	7060A2052-K	
490LT-1	90° (white) lens	7060A2052-1K	
470LT	70° lens	7060A2051-K	
470LT-1	70° (white) lens	7060A2051-1K	
414LT	14° lens	7060A2050-K	
414LT-1	14° (white) lens	7060A2050-1K	
410LT	10° lens	7060A2001-K	
410LT-1	10° (white) lens	7060A2001-1K	
405LT	5° lens	7060A2000-K	
405LT-1	5° (white) lens	7060A2000-1K	

Zoom Lens Assemblies

Use with light-engine body models.

MODEL	DESCRIPTION	PART NUMBER	
41530LT	Source Four 15°–30° Zoom lens	7060A2030-K	
42550LT	Source Four 25°–50° Zoom lens	7060A2032-K	

LED Adapters

MODEL	DESCRIPTION	PART NUMBER	
S4LEDCYC	LED CYC adapter	7460A2011	
S4LEDFRES	LED Fresnel adapter	7460A2016	

CONTROL

DMX Input Channel Profiles

DMX PROFILE	DMX CHANNELS	CHANNEL ASSIGNMENTS	NOTES
5ch (Default)	5	1-Intensity 2-Red 3-Green 4-Blue 5-Strobe	Lime is mixed automatically.
RGB	3	1-Red 2-Green 3-Blue	
1ch	1	1-Intensity	This mode controls the intensity of Preset 1.
Dir	6	1-Intensity 2-Red 3-Green 4-Blue/Indigo* 5-Lime 6-Strobe	*Original ColorSource Spot fixture uses blue in channel 4; Deep Blue ColorSource Spot fixture uses indigo in channel 4.

PHYSICAL

ColorSource Spot Weights

	WEIGHT*		SHIPPING WEIGHT	
	lb	kg	lb	kg
With Barrel	17.0	7.7	22.0	10.0
Without Barrel	13.0	5.9	16.3	7.4

* Does not include mounting hardware or lens tube

ColorSource Spot Dimensions

	HEIGHT		WIDTH		DEPTH	
	in	mm	in	mm	in	mm
ColorSource Spot	23.33	593	13.36	339	26.44	672

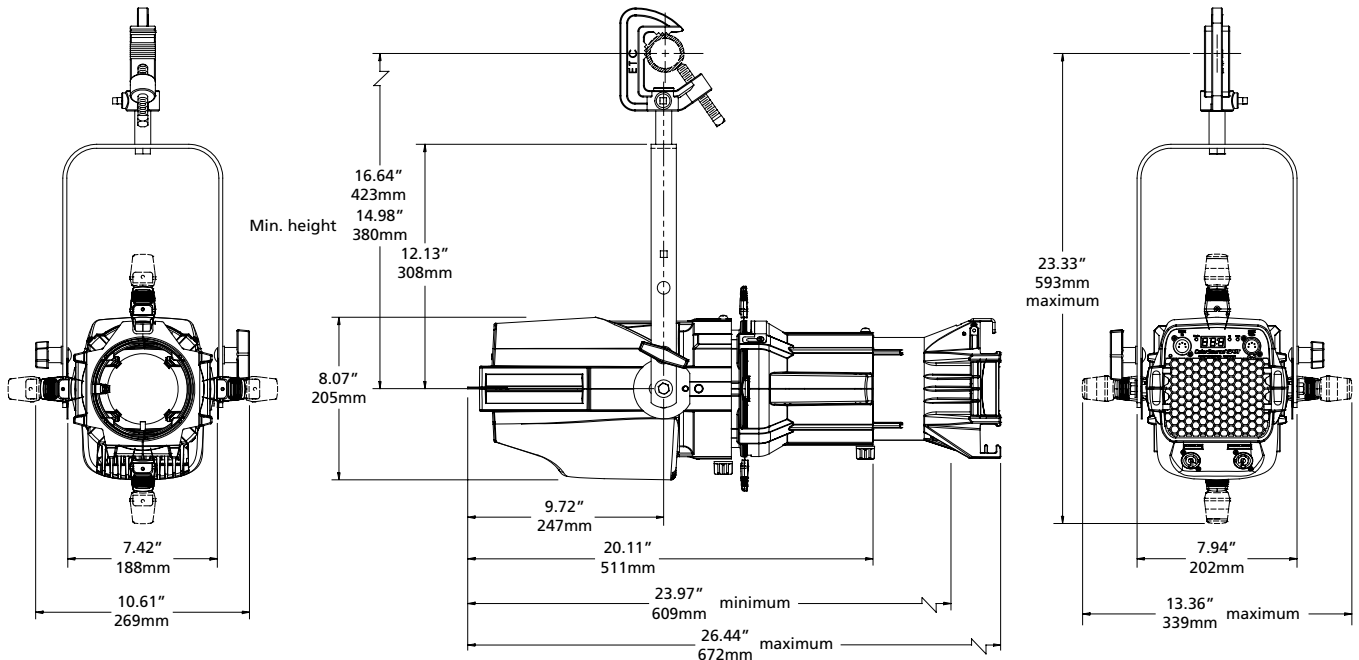

Corporate Headquarters • Middleton, WI USA
 Global Offices • London, UK • Rome, IT • Holzkirchen, DE • Paris, FR • Hong Kong
 Dubai, UAE • Singapore • New York, NY • Orlando, FL • Los Angeles, CA • Austin, TX
 Copyright©2021 ETC. All Rights Reserved. All product information and specifications subject to change. Rev N 2021-03
 *Trademark and patent info: etcconnect.com/ff